

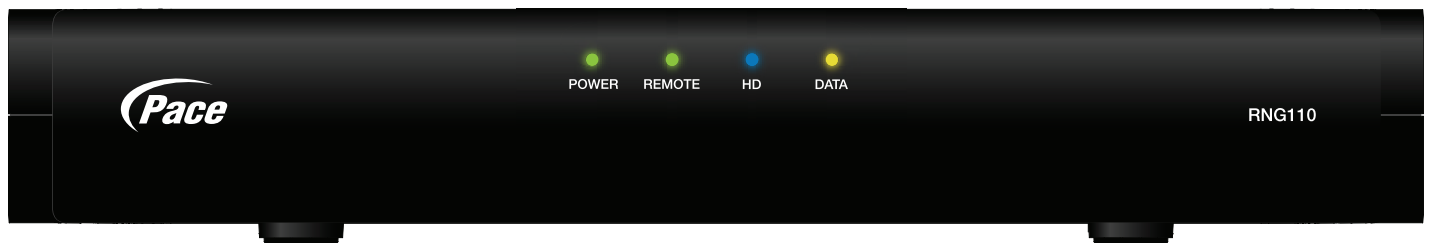

OPERATOR'S MANUAL

Pace RNG110



CONTENTS

SAFETY INFORMATION.....	3
REAR PANEL.....	6
CONNECTING THE EQUIPMENT.....	7
Setup A - Home theater system with HDTV (HDMI connection)	7
Setup B - Home theater system with HDTV (Component video / YPbPr connection)	8
Connecting the power supply unit to your set-top	8
Connecting equipment to the wall AC outlets	8
OPERATING YOUR SET-TOP	9
Turning your set-top on and off	9
Lightning storms	9
Using your remote control.....	9
Displaying a picture on your HDTV screen	10
Setting up subtitles.....	10
MAKING USER SETTINGS	11
About User Settings.....	11
About the TV Aspect Ratio	11
About TV Display Capability (resolution settings).....	12
Setting Auto Pillarbox.....	13
Making Closed Caption Settings	14
Making Front-Panel Settings.....	15
Changing HDMI Settings	15
Removing the User Settings menus	15
Restoring the factory default settings.....	16
USING ZOOM AND THE SETUP MENUS	17
Using Zoom to change the picture.....	17
Using the setup menus.....	17
SOLVING PROBLEMS	18
TERMS AND CONDITIONS FOR USE OF SOFTWARE (“TERMS”)	20
Open Source Licenses	20

This manual describes some on-screen displays such as menus. These may change in the future, if the set-top's software is updated over the cable. However, the way that you use the menus will remain similar to the way described in this manual.



Manufactured under license from Dolby Laboratories. Dolby and the double-D symbol are trademarks of Dolby Laboratories.

Macrovision

This product incorporates copyright protection technology that is protected by U.S. patents and other intellectual property rights. Use of this copyright protection technology must be authorized by Macrovision, and is intended for home and other limited pay-per-view uses only unless otherwise authorized by Macrovision. Reverse engineering or disassembly is prohibited.

HDMI

HDMI, the HDMI Logo and High-Definition Multimedia Interface are trademarks or registered trademarks of HDMI Licensing LLC.

Other trademarks listed herein are the property of their respective owners.

© 2009 Pace plc.

All rights reserved.

Pace and  are trademarks and/or registered trademarks of Pace plc

SAFETY INFORMATION

This digital set-top has been manufactured and tested with your safety in mind. However, improper use can result in potential electric shock or fire hazards. To avoid defeating the safeguards that have been built into your set-top, please observe the precautions discussed in this document.

Warnings on the power supply unit



The lightning flash with arrowhead symbol, within a triangle, is intended to alert you to the presence of uninsulated “dangerous” voltages within the power supply unit’s enclosure that may be of sufficient magnitude to constitute a risk of electric shock to persons.



The exclamation point within a triangle is intended to alert you to the presence of important instructions in the literature accompanying the set-top.

Other warnings

To reduce the risk of electric shock, do not remove the cover of your set-top. There are no user-serviceable parts inside it.

Do not perform any servicing unless you are qualified to do so. Refer all servicing to qualified service personnel. Servicing the set-top yourself will invalidate the warranty.

On the rear panel of your set-top there is a tamper-evident label that states ‘Warranty void if broken or removed’.

To reduce the risk of fire or electric shock, do not expose this set-top to rain or moisture.

Installation

The installation of your set-top should be carried out by a qualified installer and should conform to local codes.

Note to the installer

This reminder is provided to call the attention of the cable-TV-system installer to Section 820 of the National Electrical Code (USA), which provides guidelines for proper grounding and, in particular, specifies that the cable ground shall be connected to the grounding system of the building, as close to the point of cable entry as is practical.

Service address:
Pace Americas Inc.
3701 FAU Boulevard, Suite 200, Boca Raton, Florida 33431 U.S.A.

IMPORTANT SAFETY INSTRUCTIONS

Before you install or use the apparatus, you must read and understand these Important Safety Instructions.

At all times when using the apparatus you must follow these Important Safety Instructions to reduce the risk of fire, electrical shock and injury to persons.

1. Read these instructions.
2. Keep these instructions.
3. Heed all warnings.
4. Follow all instructions.
5. Do not use this apparatus near water.
6. Clean only with dry cloth.
7. Do not block any ventilation openings. Install in accordance with the manufacturer’s instructions.
8. Do not install near any heat sources such as radiators, heat registers, stoves, or other apparatus (including amplifiers) that produce heat.
9. Do not defeat the safety purpose of the polarized or grounding-type plug. A polarized plug has two blades with one wider than the other. A grounding type plug has two blades and a third grounding prong. The wide blade or the third prong are provided for your safety. If the provided plug does not fit into the outlet, consult an electrician for replacement of the obsolete outlet.
10. Protect the power cord from being walked on or pinched particularly at plugs, convenience receptacles, and the point where they exit from the apparatus.
11. Only use attachments/accessories specified by the manufacturer.
12. Use only with the cart, stand, tripod, bracket, or table specified by the manufacturer, or sold with the apparatus. When a cart is used, use caution when moving the cart/apparatus combination to avoid injury from tip-over.



13. Unplug this apparatus during lightning storms or when unused for long periods of time.
14. Refer all servicing to qualified service personnel. Servicing is required when the apparatus has been damaged in any way, such as power-supply cord or plug is damaged, liquid has been spilled or objects have fallen into the apparatus, the apparatus has been exposed to rain or moisture, does not operate normally, or has been dropped.

SAFETY INFORMATION (cont.)

In addition to the Important Safety Instructions, please read the Safety Information below.

Power sources

The model number, serial number, and electrical rating of this set-top are on a label on its base.

You must operate your set-top only from the type of power source indicated on the marking label. If you are not sure of the type of power supply to the home, consult the dealer or local power company. If you move your set-top between locations at different temperatures, allow it to reach room temperature before you apply power to it.

Overloading

Do not overload wall AC outlets, extension cords or other power outlets as this can result in a risk of fire or electric shock.

Lightning

For added protection for your set-top during a lightning storm, or when it is left unattended and unused for long periods of time, disconnect your set-top from the power supply and disconnect the cable system from your set-top. See also item 13 in the Important Safety Instructions.

Ambient temperature

The operating temperature range of your set-top is 32-104°F. If the ambient temperature around your set-top falls outside this range, you must correct this in order for your set-top to work correctly and safely. For example, if the temperature is too high, make sure there is sufficient ventilation (see below) and that your set-top is not directly on top of or underneath other equipment.

Ventilation

Slots and openings in the casing of your set-top are provided for ventilation, to ensure reliable operation of your set-top and to protect it from overheating.

- Never block the ventilation openings by placing your set-top on a bed, sofa, rug, or other similar surface. Place it on a hard, flat surface.
- Never cover the ventilation openings with items such as newspapers, table-cloths, or curtains.
- You can place your set-top near other consumer electronics devices, such as stereo amplifiers or televisions, but you must not place it directly on top or underneath them.
- Do not place your set-top in a built-in installation such as a bookcase or rack unless proper ventilation is provided and you have adhered to the manufacturer's instructions.
- **Maintain a minimum distance of three inches around your set-top for sufficient ventilation.**

See also item 7 in the Important Safety Instructions.

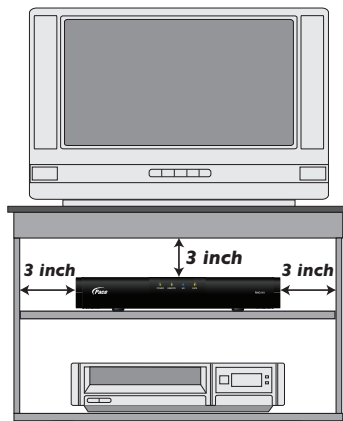

Water and moisture

Do not expose your set-top to rain or moisture, dripping or splashing, and ensure that no objects filled with liquids, such as vases, are placed on your set-top. See also item 5 in the Important Safety Instructions.

Entry of objects and liquids

Never push objects of any kind into your set-top through openings as they may touch dangerous voltage points or short-out parts that could result in fire or electric shock. Never spill liquid of any kind on your set-top.

Transporting

Move the combination of set-top and cart with care. Quick stops, excessive force and uneven surfaces may cause the combination of set-top and cart to overturn. See also item 12 in the Important Safety Instructions.

Placement and mounting

Do not place your set-top on an unstable or uneven surface. Your set-top may fall, causing serious injury to a child or adult and serious damage to your set-top. If you mount your set-top, for example to a wall or ceiling, follow the manufacturer's instructions and use a mounting accessory recommended by the manufacturer. See also item 12 in the Important Safety Instructions.

Risk of fire or scorching

Never place naked flame sources, such as lighted candles, on or adjacent to your set-top.

Replacement parts

When replacement parts are required, be sure that the service technician has used replacement parts specified by the manufacturer or that have the same characteristics as the original part. Unauthorized substitutions may result in fire, electric shock or other hazards.

See also item 14 in the Important Safety Instructions.

Safety check

Upon completion of any servicing or repairs to your set-top, ask the service technician to perform safety checks to determine that your set-top is in its proper operating condition. See also item 14 in the Important Safety Instructions.

SAVE THIS INFORMATION FOR FUTURE REFERENCE

SAFETY INFORMATION (cont.)

Safety aspects of connections

Full details of the rear panel are on page 6.

Connecting

Do not connect your set-top (or any other equipment such as a TV or VCR) to the power supply until you have properly connected all the other cables.

Your set-top is designed for use only with the supplied power supply unit.

On the power supply unit there is a label that specifies the correct AC power supply input for it. Do not connect the power supply unit to any supply other than this.

Always connect the 5 volt DC cord from the power supply unit to your set-top before you insert the power supply unit into the wall AC outlet.

Disconnecting

To disconnect power from your set-top, always remove its attached power supply unit from the wall AC outlet (i.e. do not the 5 volt cord from your set-top).

Therefore you must install your set-top near to the wall AC outlet, which should be easily accessible.

If you are in any doubt about the power supply cord, its plug or its connection, consult a qualified electrician.



The **CABLE IN** connector is designed for connection to a cable network only.

You must not connect any other equipment, such as a VCR, to this input.



POWER INPUT

The model number, serial number, and electrical rating of this set-top are on a label on its base.

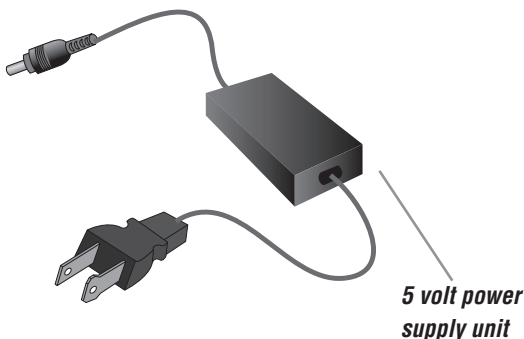

5 volt power supply unit

Regulatory information

CAUTION: Do not attempt to modify your set-top without written authorization from the manufacturer. Unauthorized modification could void your authority to operate your set-top.

NOTE

Your set-top has been tested and found to comply with the limits for a Class B digital device, pursuant to Part 15 of the FCC Rules. These limits are designed to provide reasonable protection against harmful interference in a residential installation. Your set-top generates, uses and can radiate radio-frequency energy and, if not installed and used in accordance with the instructions, may cause harmful interference to radio communications.

However, there is no guarantee that interference will not occur in a particular installation. If your set-top does cause harmful interference to radio or television reception, which can be determined by turning your set-top off and on, you are encouraged to try to correct the interference by one or more of the following measures.

- Reorient or relocate the receiving antenna.
- Increase the separation between your set-top and the receiver.
- Connect your set-top to an outlet on a circuit different from that to which the receiver is connected.
- Consult your dealer or an experienced radio/TV technician for help.

REAR PANEL

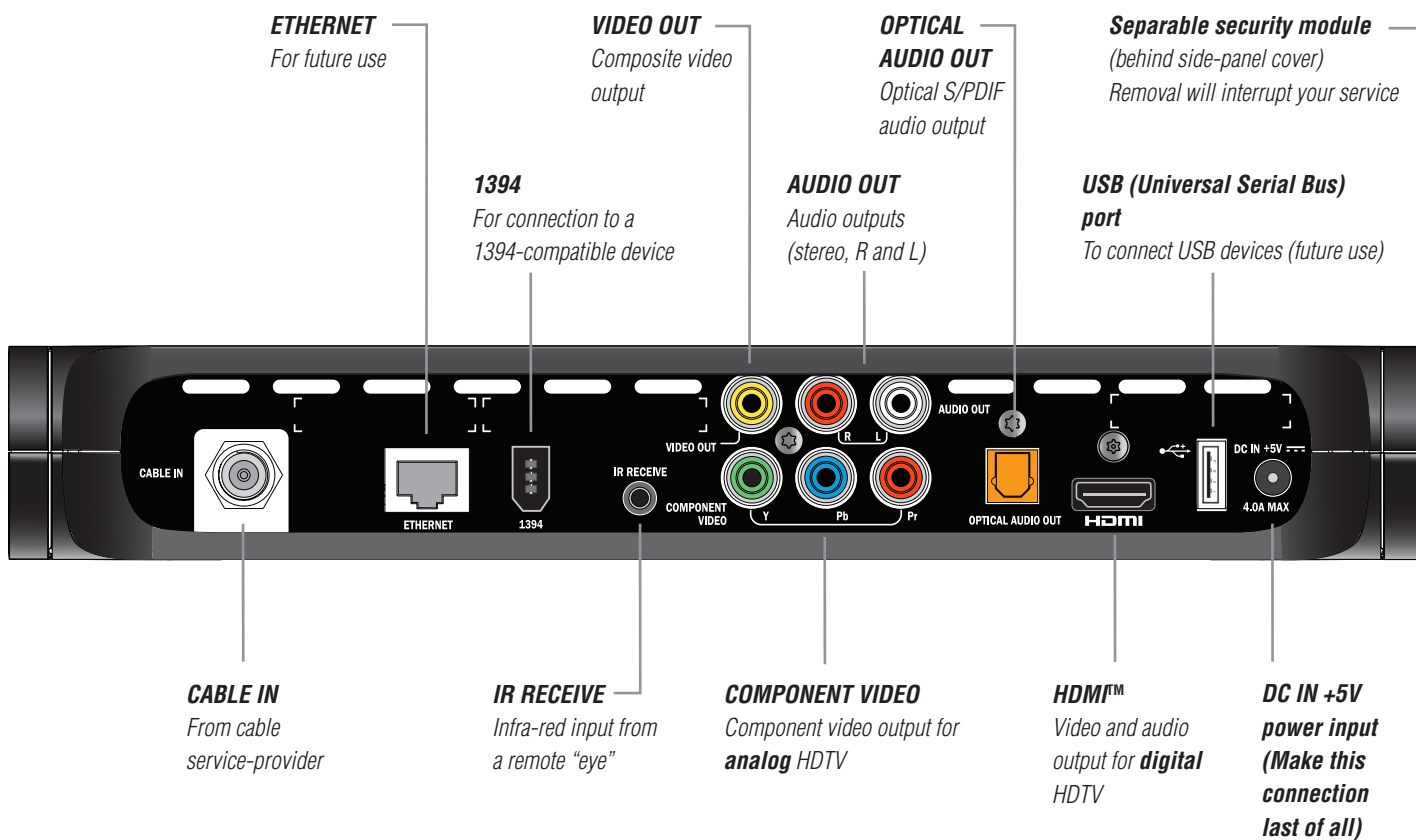

CABLE IN

Connect the cable service here.

ETHERNET

For future use.

1394

Connect to a 1394-compatible device.

IR RECEIVE

Connect to an optional remote "eye".

VIDEO OUT

Connect to the composite video input on your VCR (or a standard TV).

AUDIO OUT

Connect to the R and L audio inputs on your stereo TV, stereo VCR, or optional stereo amplifier.

COMPONENT VIDEO

If your HDTV does not have an HDMI, connect your HDTV here.

OPTICAL AUDIO OUT

Connect to the **optical** digital audio input on optional digital audio equipment.

HDMI (High Definition Multimedia Interface)

If your HDTV has an HDMI, connect it here for a **digital** audio/video connection (instead of using the AUDIO and three **analog** COMPONENT VIDEO connectors).

USB (Universal Serial Bus) port

Connect to compatible optional equipment that supports a USB 2.0 interface (future use).

Separable security module (behind side-panel cover)

Removal will interrupt your service.

DC IN +5V power input

Connect your set-top's power cord here.
Make this connection last of all.

NOTE

Copy protection via an HDMI secure link

The HDMI link between your set-top and your HDTV should be a secure link. When your set-top is attached via an HDMI cable to an HDCP-compliant (High-bandwidth Digital Content Protection) HDTV, the HDTV and set-top negotiate a secure link, which allows your set-top to transmit full resolution video (picture) to your HDTV.

Not all HDTVs support HDCP. If your set-top is connected to an HDTV that does not support it, the following may be displayed:

Your HDTV does not support HDCP. Please use the YPbPr component connection to watch TV.

The HDMI output is then disabled, so no picture is transmitted from this connector. In that case, use the component video connectors to connect up (see Setup B).

CONNECTING THE EQUIPMENT

In order for you to view programs broadcast in high-definition, your set-top must be connected to a suitable HDTV or computer monitor. Your set-top is also compatible with standard-definition TVs and VCRs.

Your equipment should have been connected up by your installer. However, if you need to disconnect and re-connect your equipment, read this page and page 8.

There are two typical connection setups for an HDTV, VCR, DVD player, and home theater receiver.

These setups make efficient use of the connectors on your set-top. However, depending on your other equipment and the connectors on it, the person who installed your system may have chosen to connect things up differently.

Both setups allow stereo recording and play-back of video tapes. You hear stereo sound from the home theater's loudspeakers.

You can take advantage of the digital audio output from your set-top by connecting a suitable cable between your home theater receiver and the OPTICAL AUDIO OUT connector (as shown in the diagrams).

WARNINGS

Do not connect your set-top (or any other equipment such as a TV or VCR) to the power supply until you have properly connected all the other cables.

Disconnect your set-top's power supply unit from the AC power supply before you disconnect any other equipment from its rear panel.

The only way to disconnect your set-top from the AC power supply is to remove the power supply unit from the wall AC outlet (or switch the wall AC outlet switch, if present, to its OFF position). Your set-top must therefore be installed near to the wall AC outlet, which should be easily accessible.

The cable input is designed for connection to a cable network only. You must not connect any other equipment, such as a VCR, to this input.

NOTES

How you set up your equipment may depend on your home theater receiver. For example, the optical audio input may be associated with a particular video input. Consult your home theater user guide for further details.

Setup A - Home theater system with HDTV (HDMI connection)

Setup A uses an HDMI connector to connect to the HDTV. This displays the highest quality picture on the HDTV and also means there will be no picture degradation on any copy-protected programs (provided the link remains secure – see page 6).

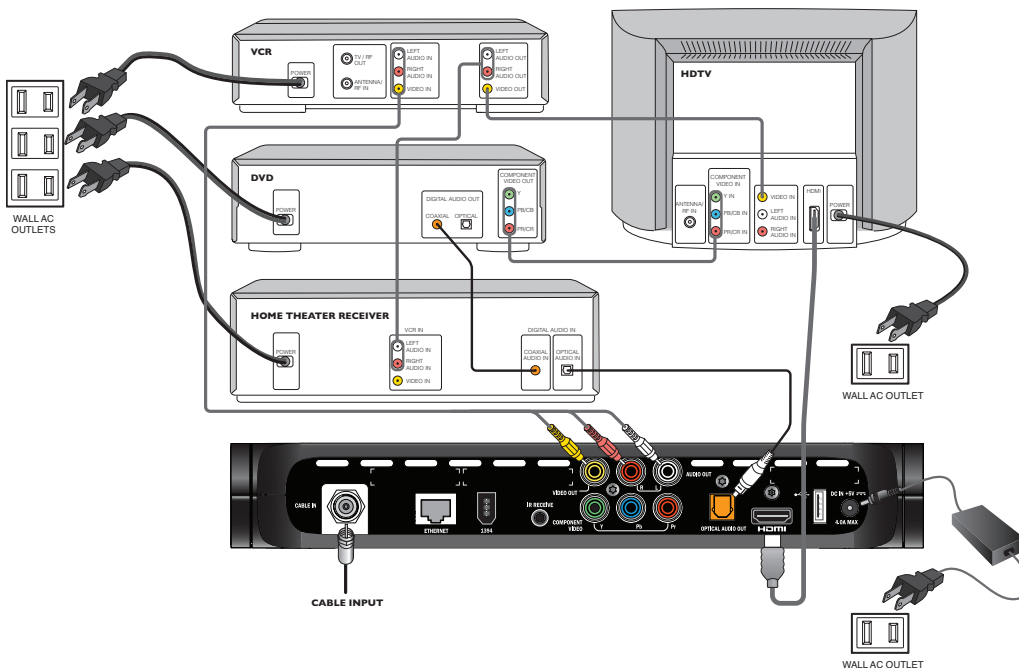

NOTE

This diagram shows a video path from the set-top to a VCR to allow recording by the VCR. It shows a video path from the VCR to the TV to allow playback of videos. Video signals fed through a VCR may be affected by copyright protection systems, which can cause picture distortion on your TV. Do not, therefore, use a path through a VCR to watch your set-top programs. Use the HDMI path or an alternate **direct** video path from your set-top to your TV. Remember to select the correct input on your TV.

CONNECTING THE EQUIPMENT (cont.)

Setup B - Home theater system with HDTV (Component video / YPbPr connection)

Setup B uses a component video connection to connect to the HDTV. This displays a high definition picture on your TV.

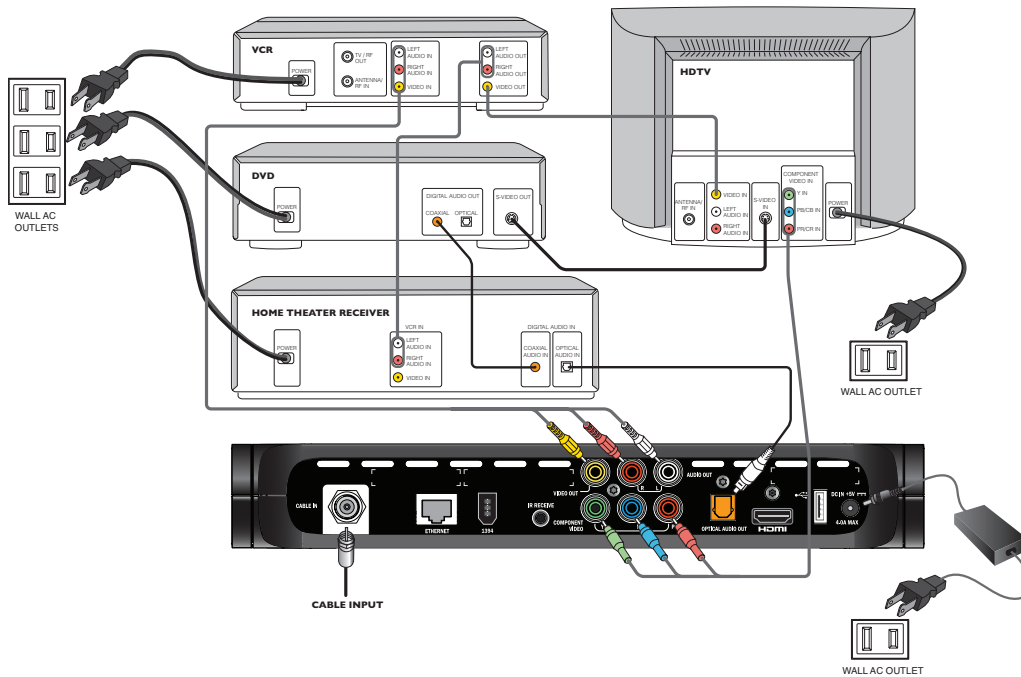

NOTE

This diagram shows a video path from the set-top to a VCR to allow recording by the VCR. It shows a video path from the VCR to the TV to allow playback of videos. Video signals fed through a VCR may be affected by copyright protection systems, which can cause picture distortion on your TV. Do not, therefore, use a path through a VCR to watch your set-top programs. Use the component video path or an alternate **direct** video path from your set-top to your TV. Remember to select the correct input on your TV.

WARNINGS

Do not connect your set-top (or any other equipment such as a TV or VCR) to the power supply until you have properly connected all the other cables.

Do not defeat the safety purpose of the polarized plugs on power cords. A polarized plug has two blades with one wider than the other. This plug fits into the wall AC outlet in only one way; match the wide blade of the plug to the wide slot of the outlet.

Connecting the power supply unit to your set-top

Before you insert the power supply unit into the wall AC outlet, connect the 5 volt DC cord from the power supply unit to the socket labeled "DC IN +5V" on your set-top's rear panel.

Connecting equipment to the wall AC outlets

Connect your set-top's power supply unit, and the polarized plugs on the power cords from your TV, VCR, and any other equipment, into wall AC outlets. If these outlets have switches, switch them ON.

OPERATING YOUR SET-TOP

Turning your set-top on and off

After you have connected your set-top's power supply unit to the wall AC outlet (and switched this outlet ON, if it has a switch), press the **POWER** button on your remote control to turn your set-top on (making sure the remote control is set to control your set-top). The **POWER** light on your set-top's front panel should light up green, to show that your set-top is on.

To turn your set-top on or off at any time, press the **POWER** button on your remote control.

Never turn off your set-top by simply disconnecting it from the power supply. If you need to disconnect your set-top, turn off your set-top by pressing the **POWER** button on your remote control, so that the **POWER** light is switched off. Then wait a few seconds before removing the power supply unit from the wall AC outlet.

Power Saving: To save power and money, and to reduce greenhouse gas emissions, turn off your set-top, using the POWER button on your remote control, when it is not in use.

NOTES

IMPORTANT: Unless there is a lightning storm or you will be away from your home for a long time, do not unplug your set-top's power supply unit at the wall AC outlet (or do not switch it off there, if the outlet has a switch). Your set-top cannot be updated with new features, through the cable, if it is disconnected from the power supply.

Your set-top's front-panel

REMOTE light

Lights green when your set-top is receiving a signal from your remote control

HD light

Lights blue when your set-top is receiving High-Definition Television (HDTV) content

POWER light

Lights green when your set-top is on; not lighted when your set-top is in standby or is disconnected from the power supply

DATA light

Lights yellow when your set-top is receiving data and when there is an unread message

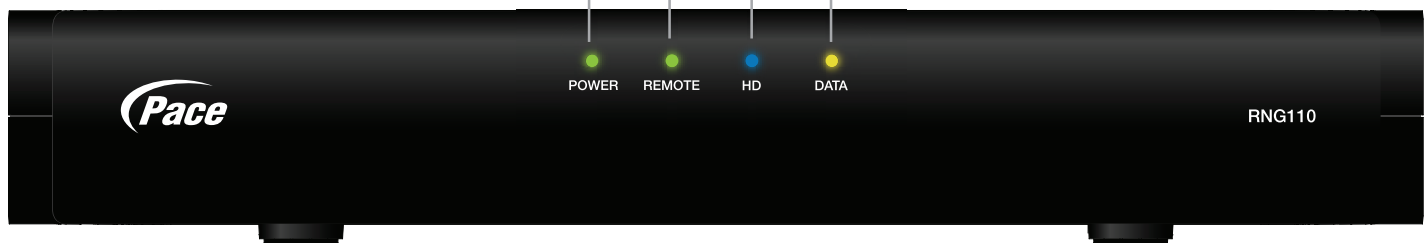

Lightning storms

Disconnect your set-top from the power supply during lightning storms. A lightning storm may affect your set-top, if it is on during the storm. It may appear that it has stopped working, but you can easily restore its operation as follows:

Unplug your set-top's power supply unit from the wall AC outlet. Then plug this power supply unit in again at the wall AC outlet (and, if there is a switch by this outlet, switch it to its ON position).

Using your remote control

Your cable TV service-provider determines the digital channels, services, and screen information that you see on your TV when you use your set-top and its remote control.

Consult the information supplied by your cable service-provider for details on how to make the most of the digital cable services. Also read the operating instructions that are supplied with your remote control.

OPERATING YOUR SET-TOP (cont.)

Displaying a picture on your HDTV screen

If your set-top is connected to your HDTV's component video or HDMI input and is turned on (the **POWER** light is green), but your HDTV does not initially display a picture from your set-top, your HDTV may not support your set-top's current output resolution (for further details on resolutions, see page 12). You therefore need to change your set-top's output resolution as follows:

1. First press the **POWER** button on your remote control (**POWER** light goes off), then press the **MENU** button.
2. Next, press the **ZOOM** button on your remote control (the button could be labeled **ASPECT**) until a picture appears.
Each button-press changes your set-top's output resolution, which also appears on the TV screen.
After a few seconds, you should see the PACE USER SETTINGS menu.
3. Press the **POWER** button to remove this menu and return to normal viewing.

Current output resolution from your set-top

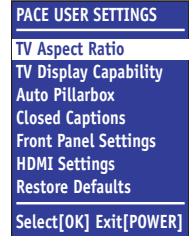

Setting up subtitles

Subtitles in various languages may be transmitted with TV programs. You can set up your set-top to display subtitles, when they are available. You can also set your preferred language for these subtitles. There is a choice of several languages, including English.

If you set subtitles to be "on", they will be displayed in the preferred language only when subtitles in that language are transmitted with a program. For example, if you set subtitles to be "on" and in Spanish, but only French subtitles are transmitted with a particular program, you will see French subtitles for that program, not Spanish.

Note: You can also turn on closed captions (see page 14) to give subtitles, but any subtitles you set up using this PACE SUBTITLE SETTINGS menu will take priority.

Selecting subtitles in your preferred language

1. Make sure that your set-top is turned on (the **POWER** light is green).
2. Press the **POWER** button on your remote control (**POWER** light goes off), then press the **INFO** button.
The PACE SUBTITLE SETTINGS menu appears on the TV screen (see right).
3. Press **▲** or **▼** to highlight "Subtitles", then press **OK/Select** to turn them on or off.
4. Press **▲** or **▼** to highlight "Subtitle Language", then use the **OK/Select** button to choose the language you want (the language changes each time you press **OK/Select**).
5. When you have finished making changes, press the **POWER** button to remove the PACE SUBTITLE SETTINGS menu and return to normal viewing.

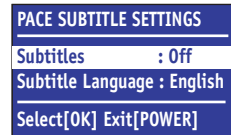

MAKING USER SETTINGS

About User Settings

Your installer should have made the correct settings so that your set-top is compatible with your HDTV or TV. However, you may wish to change some settings, for example if you purchase a new HDTV. You can make the following settings and you can also reset them to the factory defaults.

- TV Aspect Ratio (the screen's width-to-height ratio, or shape)
- TV Display Capability (screen resolution)
- Auto Pillarbox
- Closed Captions
- Front Panel Settings
- HDMI Settings

You use the buttons on your remote control to make the settings using on-screen menus. However, until your set-top has been set up to match the display capability of your TV (see page 12), these menus may not be visible.

Putting your set-top into User Settings mode

1. Make sure that your set-top is turned on (**POWER** light is green).
2. Press the **POWER** button on your remote control (**POWER** light goes off), then press the **MENU** button. You should see the PACE USER SETTINGS menu, shown right, on your TV screen.
3. When you have finished making changes (see pages 11 through 15), press the **POWER** button to remove the PACE USER SETTINGS menu and return to normal viewing.



About the TV Aspect Ratio

The TV that you have connected to your set-top has an aspect ratio (width-to-height ratio) of 4:3 (basic/standard) or 16:9 (widescreen). You must set the appropriate TV Aspect Ratio (4:3 or 16:9) on your set-top, so that it is compatible with your TV.

Setting the TV Aspect Ratio

If you have not done so already, put your set-top into User Settings mode, as described above.

Press the ▲ or ▼ button on your remote control and highlight TV Aspect Ratio on the PACE USER SETTINGS menu.

1. Press the ▲ or ▼ button on your remote control and highlight TV Aspect Ratio on the PACE USER SETTINGS menu.

2. Press the ► button.

The TV Aspect Ratio menu, shown below, appears on your TV screen. On the menu, the current setting ("4:3" or "16:9") has > in front of it. Also, whenever the current setting is displayed, the DATA light will be lighted on your set-top's front panel.

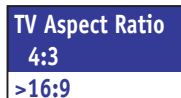

3. Press the ▲ or ▼ button to highlight the TV Aspect Ratio you want.
4. Press the **OK/Select** button to confirm your choice and change to that TV Aspect Ratio.
5. Press the ◀ button. The PACE USER SETTINGS menu reappears.

To continue making the settings, see the next section.



4:3 standard TV,
EDTV or HDTV



16:9 HDTV

MAKING USER SETTINGS (cont.)

About TV Display Capability (resolution settings)

- **Your set-top** can transmit pictures to your TV in a range of resolutions (also called “Display Capabilities” - see below for the settings available). Generally, higher screen resolutions give better quality pictures. However, the quality always depends on how the program was originally transmitted.
- **Different TVs** display different screen resolutions. For example, standard TVs display “480i”, EDTVs (Enhanced Definition TVs) display “480p”, and most HDTVs display “1080p”, “1080i” or “720p”. Many HDTVs will display at more than one resolution. For more information, see the information supplied with your HDTV.

You must make the appropriate TV Display Capability settings on your set-top, so that it is compatible with your TV. See below for full instructions.

In order to display the best picture every time, you must select **every** resolution that your TV is capable of displaying. This ensures that programs are displayed with minimum distortion.

There is a blue **HD** light on your set-top’s front panel that lights when your set-top is receiving high-definition content.

TV Display Capability settings

- **480i** is standard definition NTSC and is transmitted in a 4:3 aspect ratio (see right).
- **480p** is enhanced digital TV and can be transmitted in either a 4:3 or 16:9 aspect ratio.
- **720p, 1080i**, and **1080p** are HDTV and are transmitted in a 16:9 aspect ratio (see right).



480i transmission:
The aspect ratio is 4:3



1080i transmission:
The aspect ratio is 16:9

Changing the TV Display Capability

If you have not already done so, put your set-top into User Settings mode, as described on page 11.

1. Press the ▲ or ▼ button on your remote control and highlight TV Display Capability on the PACE USER SETTINGS menu.
2. Press the ► button.

The TV Display Capability menu appears on your TV screen. The available resolutions are: 1080p24*, 1080p30*, 1080i, 720p, 480p, and 480i.

TV Display Capability	
1080i	: YES
720p	: NO
480p	: YES
480i	: YES
1080p24 Pass	: NO
1080p30 Pass	: NO

3. Press the ▲ or ▼ button to highlight each resolution in turn and, for each one, press the **OK/Select** button if you wish to change the setting (the setting changes between “YES” and “NO” each time you press **OK/Select**).

If, at any stage in this process, the menu disappears from the screen, immediately press the OK/Select button to restore the menu.

4. When you are satisfied that all the TV resolutions are correct, press the ◀ button. The PACE USER SETTINGS menu reappears.

NOTE

When your HDTV is connected to your set-top via an HDMI connector, your set-top gets information from your HDTV about the HDTV’s display capability. Your set-top uses this information to adjust its TV Display Capability settings.

Your set-top also records your HDTV’s ID (identification), so that only one HDTV is supported at any one time. When your HDTV has updated your set-top’s TV Display Capability settings, you may change them if you wish. Your changes will then be stored with the ID.

You can restore your set-top’s TV Display Capability settings to their factory values, as described on page 16. You can also restore your set-top to the settings that your HDTV has passed to your set-top. To do this you must first restore the factory settings while the HDMI cable is disconnected from your set-top, then reconnect your HDTV via the HDMI cable.

* NOTE

If your HDTV is 1080p-compliant and connected by HDMI, setting “1080p24 Pass” to YES causes 1080p/24 transmissions (at 24 frames per second) to be displayed at 1080p/24. Likewise, setting “1080p30 Pass” to YES causes 1080p/30 transmissions (at 30 frames per second) to be displayed at 1080p/30.

The HDMI-connected HDTV may report that it is not 1080p-compliant and set “1080p24 Pass” (or “1080p30 Pass”) to NO. In this case 1080p transmissions will be output at one of the other resolutions (1080i, 720p, 480p or 480i). If you override this NO setting and set YES, you may see nothing for 1080p transmissions.

If the HDTV is not connected by HDMI, “HDMI Cable Required” is displayed and you cannot set “1080p24 Pass” or “1080p30 Pass” to either YES or NO.

Transmissions at 480i, 480p, 720p or 1080i can never be output at 1080p.

MAKING USER SETTINGS (cont.)

Further information about the TV Display Capability

The TV Display Capability settings relate to equipment that is connected to the HDMI and COMPONENT VIDEO OUT connectors because the settings control the output at those connectors. If equipment is connected via an HDMI cable, that equipment may also pass information back to your set-top, which may affect what settings are available.

Generally, the TV Display Capability settings do not affect equipment connected to the VIDEO OUT connector, because the output at this connector will always be the standard definition 480i.

Setting Auto Pillarbox

If your TV is a 16:9 TV that does not automatically detect 4:3 transmissions (and therefore does not add black bars to the sides of the picture), then 4:3 transmissions *may* display “stretched” to fit the 16:9 screen. If you do not want this effect, you can set your set-top to add black bars to the 4:3 picture, so that it is transmitted to your TV at a 16:9 aspect ratio. See the example below.

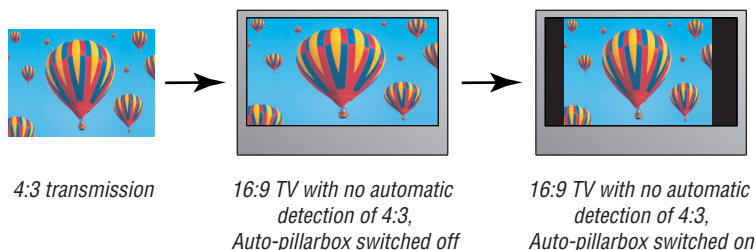

Changing the Auto Pillarbox setting

If you have not done so already, put your set-top into User Settings mode, as described on page 11.

1. Press the ▲ or ▼ button on your remote control and highlight Auto Pillarbox on the PACE USER SETTINGS menu.
2. Press the ► button. The Auto Pillarbox menu appears on your TV screen.
3. If you want to change the setting, press ▲ or ▼. Press the **OK/Select** button to confirm the choice and change to the new setting.
4. Press the ◀ button. The PACE USER SETTINGS menu reappears.

Auto Pillarbox
YES
>NO

> shows current setting

NOTE

16:9 picture in a 4:3 transmission

Sometimes, 4:3 transmissions may contain a 16:9 picture, with black borders at the top and bottom. On a 16:9 TV, this may display with black borders all the way around the picture. To remove these borders, you can use the “Zoom function” button on your remote control (could be labeled ZOOM or ASPECT). See the example below. For more information about using “Zoom”, see page 17.

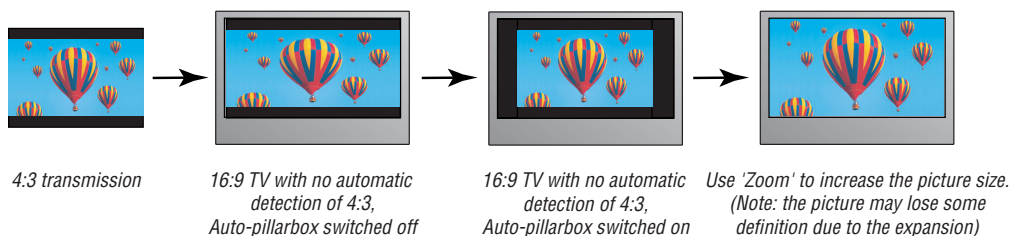

MAKING USER SETTINGS (cont.)

Making Closed Caption Settings

Closed captioning is a means of displaying alerts and subtitles on your TV screen, superimposed on whatever you are watching. You can turn closed captions on or off, as required, and you can also change the closed captions' appearance.

Turning closed captions on or off

If you have not done so already, put your set-top into User Settings mode, as described on page 11.

1. Press the ▲ or ▼ button on your remote control and highlight Closed Captions on the PACE USER SETTINGS menu.
2. Press the ► button. The Closed Captions menu appears (see right).
The current Closed Captions (CC) setting, either "ON" or "OFF" is highlighted on the menu.
3. If you want to change the setting, press the **OK/Select** button - the setting changes.
4. Press the ◀ button. The PACE USER SETTINGS menu reappears.

Closed Captions
CC : OFF
Configure Captions

To continue making the settings, see the next section.

Changing the closed captions' appearance

If you want to change the closed captions' appearance, you can see the effect of your settings by looking at the example below the menu.

1. In the Closed Captions menu (see above), press the ▼ button to highlight "Configure Captions", then press **OK/Select**. The Configure Captions menu appears (see right).
2. Use the ▲ and ▼ arrows to highlight each option in turn. Use the **OK/Select** button to choose the setting you want (the setting changes each time you press **OK/Select**).
3. If you wish to reset all the Closed Caption settings to their default values (mainly Auto), press the ▼ button to highlight "Reset to Defaults" in the menu, then press **OK/Select**.
4. When you have made all the changes you want to make, press ◀ twice to redisplay the PACE USER SETTINGS menu.

Configure Captions	
Size	: Small
Font	: Style 1
Character Color	: White
Character Shading	: Auto
Background Color	: Black
Background Shading	: Auto
Std Def CC	: Auto
Hi Def CC	: Service 1
Reset to Defaults	

Closed Caption Example

MAKING USER SETTINGS (cont.)

Making Front-Panel Settings

You can use the Front Panel Settings menu to set the brightness level of the front-panel lights when your set-top is being used (“Viewing Brightness”) and when it is switched off (“Standby Brightness”).

If you have not done so already, put your set-top into User Settings mode, as described on page 11.

1. Press the ▲ or ▼ button on your remote control and highlight Front Panel Settings on the PACE USER SETTINGS menu.
2. Press the ► button. The Front Panel Settings menu, shown right, appears on your TV screen.
3. Press the ▲ or ▼ button to highlight “Standby Brightness” or “Viewing Brightness” as required.
4. Use the **OK/Select** button to choose the setting you want (the setting changes each time you press **OK/Select**): “Low”, “Std” (Standard), or “High”. Look at the dimming and brightening of the front-panel lights while you are making the settings, to see the effect of your selections.
5. When you have made all the changes you want to make, press ◀ to redisplay the PACE USER SETTINGS menu.



Front Panel Settings
Standby Brightness : Std
Viewing Brightness : High

Changing HDMI Settings

You can use the HDMI Settings menu to choose an Audio Output Mode, and to enable or disable automatic detection of a newly connected HDTV (when using an HDMI cable).

If you have not done so already, put your set-top into User Settings mode, as described on page 11.

1. Press the ▲ or ▼ button on your remote control and highlight HDMI Settings on the PACE USER SETTINGS menu.
2. Press the ► button. The HDMI Settings menu, shown right, appears.
3. Press the ▲ or ▼ button to highlight “Audio Output Mode” or “Disable Auto Detect” as required.
4. Use the **OK/Select** button to choose the setting you want (the setting changes each time you press **OK/Select**).

Audio Output Mode has three possible settings:

“Auto” (provides the audio format best suited to the connected equipment)

“L-PCM” (provides PCM audio only)

“Pass Through” (maintains the original incoming-audio format)

Disable Auto Detect is either “YES” or “NO”.

5. When you have made all the changes you want to make, press ◀ to redisplay the PACE USER SETTINGS menu.

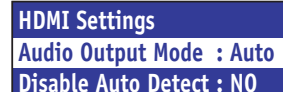

HDMI Settings
Audio Output Mode : Auto
Disable Auto Detect : NO

Removing the User Settings menus

When you have finished making all the user settings you wish to make, press the **POWER** button to remove the PACE USER SETTINGS menu and return to normal viewing.

MAKING USER SETTINGS (cont.)

Restoring the factory default settings

If you wish, you can restore the user settings to their factory defaults. All the changes you have made will be lost and the settings will revert to those that were programmed in the factory.

The factory settings are:

USER/SUBTITLE SETTINGS menu item	Options	Factory default setting
TV Aspect Ratio	–	16:9
TV Display Capability	1080i 720p 480p 480i 1080p24 Pass 1080p30 Pass	Yes No Yes Yes No No
Auto Pillarbox	–	No
Closed Captions	–	Off
Configure Captions	Various	All Auto except Hi Def CC, which is Service 1
Front Panel Settings	Standby Brightness Viewing Brightness	Std High
HDMI Settings	Audio Output Mode Disable Auto Detect	Auto No
Subtitles	–	Off
Subtitle Language	–	English

If you have not done so already, put your set-top into User Settings mode, as described on page 11.

1. Press the ▲ or ▼ button on your remote control and highlight Restore Defaults on the PACE USER SETTINGS menu.
2. Press the ► button. The message: "Restore Default. Press OK to confirm" appears on your TV screen. (If, at this stage, you no longer wish to restore the factory settings, press the ◀ button.)
3. To confirm and restore the factory settings, press the **OK/Select** button. The factory settings are restored, and the PACE USER SETTINGS menu reappears.
4. If you want to continue changing the settings, see the sections from page 11 onwards. If you have finished changing the settings, press the **POWER** button. Your set-top then switches on with the restored settings.

NOTES

If your set-top and HDTV are connected via a standard HDMI cable, your HDTV may pass information about the required settings back to your set-top (see page 12). If you wish to restore your set-top's settings to those created by your HDTV, you must disconnect the HDMI cable from your set-top before you restore the factory default settings. When you reconnect your HDTV to your set-top via the HDMI cable, your HDTV will pass back the information again.

Always turn off your set-top, then disconnect your set-top's power supply unit from the wall AC outlet before you connect or disconnect any other equipment to or from your set-top's rear panel.

USING ZOOM AND THE SETUP MENUS

Using Zoom to change the picture

Making the appropriate TV Aspect Ratio and TV Display Capability settings (see pages 11 and 12) should ensure that the picture on your TV screen is not distorted (stretched or squashed) and that it fills as much of the screen as possible.

However, even if you have selected the correct settings, there may be times when a program appears with black borders either at the top and bottom or at the sides of the picture (or sometimes even all the way round the picture). This happens because the aspect ratio (shape) of the **transmitted program** does not match the aspect ratio of your HDTV, or because the transmitted programme includes black borders as part of the transmission (see right).

Your remote control should have a “zoom function” button (could be labeled ZOOM or ASPECT), which you can use to change the TV picture until it appears as you want it to.

1. Press the “zoom function” button once to change the display.
2. Press it again to change the display again. Continue to press it in this way until the picture appears as you want it to.

Note: The effect that this button has on transmissions depends on the transmission itself. On some transmissions it may have no effect at all.

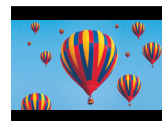

A 4:3 **transmission**, with a 16:9 picture. Dark bars are added at the top and bottom of the transmission.

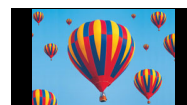

A 16:9 **transmission**, with a 4:3 picture in it. Dark bars are added at the sides of the transmission.

Using the setup menus

In addition to the user settings described on pages 11 through 15, setup menus may be available in your on-screen guide. These should be described in the information provided by your service-provider. There may also be on-screen information to explain these menus.

However, certain settings may affect how your set-top and TV work. See the table below for information about typical menu items and settings (they depend on which on-screen guide is running on your set-top, so may vary from those given below).

Item	Options	Settings	Notes
Cable Box Setup	Configuration		Allows you to view the configuration of your set-top.
Audio	Default Audio Track	Channel Default, English, various other languages	Sets the language track that your set-top first attempts to use when tuning to a channel. “Channel Default” means your set-top uses the default audio track for the program. Selecting a language means it uses the corresponding language track, if available.
	Optimal Stereo		Selecting this option enables your set-top to regulate the volume to minimize sudden changes in volume, for example during a commercial break.
	Audio Output	TV Speakers, Stereo, Advanced	If you select “Advanced”, further settings are displayed, allowing you to set the Compression (to None, Light, or Heavy) and the Stereo Output (to Mono, Stereo or Matrix Stereo).
Screen position			This allows you to adjust how the picture displays on your TV screen.

Other items and options may be available on these screens. The menus may be subject to change in the future, as your set-top advances with new technology.

SOLVING PROBLEMS

If the installed system does not seem to be working properly, first make sure that all the cables are securely connected, then carry out the following checks, in the order shown.

Check	Suggested solution	Further checks, if there is still a problem
<p>Is anything lighted on your set-top's front panel?</p> <p>YES ▼</p> <p>NO ►</p>	<p>Press the POWER button on your remote control to turn on your set-top.</p>	<p>Power may not be reaching your set-top. Make sure that the power supply unit is properly plugged in.</p> <p>If there is a switch by the wall AC outlet, switch it ON. (Note: your set-top's lights flash briefly when you apply power to the power-supply unit, then the POWER light, and probably all the other lights, go off.)</p> <p>Check that the wall AC outlet is working (for example by plugging in a lamp).</p>
<p>Does your remote control operate your set-top?</p> <p>YES ▼</p> <p>NO ►</p>	<p>Check if the POWER light on the front panel is green. If it is not, press POWER on your remote control to turn on your set-top.</p>	<p>Check that nothing is blocking the path from your remote control to the front panel.</p> <p>Check that your remote control is currently set to operate your set-top (consult the instructions supplied with your remote control).</p> <p>If your remote control will still not operate your set-top, replace the batteries in your remote control.</p>
<p>Can you see a picture on your TV screen?</p> <p>YES ▼</p> <p>NO ►</p>	<p>Your TV and other equipment may not be turned on. Check that they are plugged into wall AC outlets and turned on.</p>	<p>Check that you have selected the appropriate AV input on your TV: HDMI, component video (YPbPr) or composite video (depending on how your system is connected up).</p> <p>If you are using the HDMI connection, make sure the connection goes directly from your set-top to your TV. If your set-top detects that the link is not secure, your set-top will not transmit a picture (see page 6). If you expect the link to be secure, try disconnecting and reconnecting the HDMI cable.</p> <p>Make sure your set-top's TV Display Capability settings are appropriate for your TV (see page 12). For more information on displaying a picture on your HDTV screen see page 10.</p>
<p>Is the picture distorted or too small?</p> <p>NO ▼</p> <p>YES ►</p>	<p>Check that the TV Aspect Ratio and TV Display Capability, as set on your set-top, are appropriate for your TV (see pages 11 and 12). Change them if necessary.</p>	<p>If your TV is a 16:9 TV, you can use Auto Pillarbox to add black borders to 4:3 transmissions, so that the picture is not stretched (see page 14).</p> <p>If the TV Aspect Ratio and TV Display Capability settings are correct, try using Zoom to improve the picture (see page 17) or consult the instructions that came with your TV and try adjusting your TV's display.</p>
<p>Can you display menus and guides on the screen?</p> <p>YES ▼</p> <p>NO ►</p>	<p>If your TV is connected to the VIDEO OUT connector, then you will see menus and guides only if the screen resolution 480i is set to "Yes" and all the others are set to are set to "No".</p>	<p>Change the TV Display Capability resolution settings if necessary (see page 12).</p>
<p>Is there any sound?</p> <p>YES ▼</p> <p>NO ►</p> <p>See the next page</p>	<p>Check that the audio cables are securely and correctly connected.</p>	<p>Check that you have not muted the sound on your set-top and/or TV. Adjust the volume control on your set-top and/or TV. If you are using a home theater receiver, check it is set up correctly.</p>

SOLVING PROBLEMS (cont.)

Check	Suggested solution	Further checks, if there is still a problem
<p>Can you hear stereo sound?</p> <p style="text-align: center;">YES ▼</p> <p style="text-align: right;">NO ►</p>	<p>First check that the program is likely to have stereo sound (an old movie, for example, may not be in stereo).</p> <p>Check the on-screen Setup Menu, Audio settings (see page 17). The Stereo Output may be set to "Mono". Change it to "Stereo".</p>	<p>If your TV is mono, you will hear stereo sound only if you have a stereo audio amplifier and speakers or home theater connected to your stereo VCR or set-top.</p>
<p>Can you see and hear a DVD that you are trying to play?</p> <p style="text-align: center;">YES ▼</p> <p style="text-align: right;">NO ►</p>	<p>Check that all the audio and video cables are securely and correctly connected, including any to a home theater receiver that you may be using to enhance the sound.</p>	<p>—</p>
<p>Is the picture low quality, or "fuzzy", when you are expecting to see an HDTV-quality picture?</p> <p style="text-align: right;">YES ►</p>	<p>Some programmes may include "copy protection" which means, if your set-top is connected to your HDTV via the component video connectors, the picture is downgraded to standard TV quality. To prevent this from happening, use an HDMI connection instead.</p>	<p>—</p>

TERMS AND CONDITIONS FOR USE OF SOFTWARE (“TERMS”)

THE PRODUCT TO WHICH THESE TERMS RELATE (THE “PRODUCT”) INCORPORATES SOFTWARE WHICH IS OWNED BY PACE plc (“PACE”) OR ITS THIRD PARTY LICENSORS (THE “SOFTWARE”). BEFORE USING THE PRODUCT PLEASE READ THESE TERMS. IF YOU DO NOT AGREE TO THESE TERMS YOU MAY NOT USE THE PRODUCT AND SHOULD IMMEDIATELY RETURN THE PRODUCT TO YOUR SUPPLIER. THESE TERMS ALSO APPLY TO ANY MODIFICATIONS, UPDATES OR SUPPLEMENTS TO THE SOFTWARE PROVIDED TO YOU. FOR PURPOSES OF THESE TERMS, “YOU” MEANS YOU, THE END USER, AND YOUR PRODUCT SUPPLIER, UNLESS THE CONTEXT REQUIRES OTHERWISE.

A. License Grant and Conditions

1. Pace, or your supplier, if applicable, grants you a non-exclusive, non-transferable, limited license to use the Software solely as integrated with, incorporated into, or provided for use in connection with the Product.
2. Pace reserves all rights not expressly granted to you under these Terms.
3. You may not transfer any of your limited rights in the Software without the prior written consent of Pace, and if consent is provided then the Software shall only be transferred in conjunction with the transfer of the Product AND ONLY IF the transferee has read and agreed to accept these Terms.
4. You must ensure that the copyright, trademark and other protective notices contained in the Software are maintained and not altered or removed.
5. The Software is protected by copyright and other laws and international copyright and other treaties.
6. The Software provided hereunder is licensed (not sold). Pace is NOT transferring title or any ownership rights in the Software to you.
7. All title and intellectual property rights in and to the Software and all modifications, updates, enhancements and derivative works of the Software are owned exclusively by Pace or its licensors and you agree to execute any document reasonably requested by Pace to evidence such ownership rights.
8. Certain third party software used in connection with the Product may be made directly available to you by operating system or other third party providers. Use of such Software is also subject to the terms of any applicable agreement between you and such third party.

B. License Restrictions

Except as expressly permitted herein or by statute you may not:

1. use the Software in conjunction with any other hardware or equipment other than the Product;
2. copy or modify all or any portion of the Software;
3. incorporate all (or any portion of) the Software into other programs developed or used by (or on behalf of) you;
4. reverse engineer, decompile, decrypt or disassemble the Software (or any portion of the Software); or
5. export, transfer or re-export the Software in violation of any applicable law.

C. Open Source Software

Certain components of the Software are subject to either:

- (i) the GNU General Public Licence (“GPL”);
- (ii) the GNU Lesser General Public Licence (“LGPL”); or
- (iii) OpenSSL license.

The foregoing are not subject to the restrictions in Section B. In compliance with the GPL and LGPL Pace makes the source code of the Linux software, libraries and associated utilities it uses, together with its modifications (if any), available to the public in source code form at: <http://www.pace.com/opensource/request>. You are free to use, modify and distribute the Linux software and any modifications as long as you comply with the terms of the GPL or LGPL referred to above. The License terms applicable to (i) to (iii) above are available to you, as explained in the section below entitled Open Source Licenses.

The Software also contains the following:

- (iv) SHA library Copyright © 2000-2001, Aaron D. Gifford All rights reserved.
- (v) Expat XML Parsing Library
Copyright © 1998, 1999, 2000 Thai Open Source Software Centre Ltd and Clark Cooper.
Copyright © 2001, 2002, 2003 Expat maintainers.
- (vi) Expat++ This component of the Software is subject to the Mozilla Public License Version 1.0.
- (vii) Base64 Algorithm Copyright © 2001 Bob Trower, Trantor Standard Systems Inc.

Certain additional license terms applicable to (iv) to (vi) above are available to you, as explained in the section below entitled Open Source Licenses.

D. Termination

These Terms are effective until terminated. You may terminate these Terms by returning the Product to your supplier. These Terms will terminate automatically without notice if you fail to comply with these Terms or any other written agreement between you and Pace. Upon termination you must return the Product to your supplier.

E. Disclaimer

1. EXCEPT AS SET FORTH IN ANY WRITTEN AGREEMENT BETWEEN YOU AND PACE (OR YOUR SUPPLIER), THE SOFTWARE IS (TO THE EXTENT PERMITTED BY LAW) SUPPLIED “AS IS” AND PACE AND ITS LICENSORS EXPRESSLY EXCLUDE ALL WARRANTIES, EXPRESS OR IMPLIED, INCLUDING (BUT NOT LIMITED TO) WARRANTIES OF MERCHANTABILITY, SATISFACTORY QUALITY, FITNESS FOR PURPOSE AND NON-INFRINGEMENT.
2. EXCEPT AS SET FORTH IN ANY WRITTEN AGREEMENT BETWEEN YOU AND PACE, IN NO CIRCUMSTANCE WILL PACE BE LIABLE FOR ANY DIRECT, INDIRECT, CONSEQUENTIAL, SPECIAL, PUNITIVE OR INCIDENTAL DAMAGE (INCLUDING LOSS OF PROFITS, BUSINESS INTERRUPTION, LOSS OF DATA OR THE COST OF PROCUREMENT OF SUBSTITUTE GOODS, TECHNOLOGY OR SERVICES) ARISING OUT OF THE USE OR THE INABILITY TO USE THE SOFTWARE.

F. General

These Terms are governed by the laws of the State of New York and you may only bring claims exclusively in New York courts and Pace shall be entitled to bring a claim in the courts of any jurisdiction. Any failure by Pace to enforce any of its rights hereunder or applicable law shall not constitute a waiver of such rights. Pace’s licensors and suppliers shall be third party beneficiaries of this License Agreement, as applicable.

YOUR USE OF THE PRODUCT CONSTITUTES YOUR ACKNOWLEDGEMENT THAT YOU HAVE READ THESE TERMS AND AGREE TO BE BOUND HEREBY.

Open Source Licenses

The software contained in this product may be covered by certain components consisting of free software or open source software. A list of these components and a copy of the relevant copyright notices and license term notices that are required by such licenses are available at this web page:

<http://www.pace.com/opensource/license>

This list may change from time to time and may depend on the model of product or the version of software you have received. If you are unable to access this web page and wish to have a copy of this list, please contact the Open Source Administrator at: 3701 FAU Boulevard, Suite 200, Boca Raton, Florida 33431 USA. To the extent the terms of these open source or free software licenses prohibit any of the restrictions in any end user license included with the product, such restrictions will not apply to the applicable open source or free software component.



www.pace.com

Pace and  are trademarks and/or registered trademarks of Pace plc.

501-3438000